

COMPRAR
TOLDOS.COM

PARASOL

CATÁLOGO 2025

EOLO PURETI

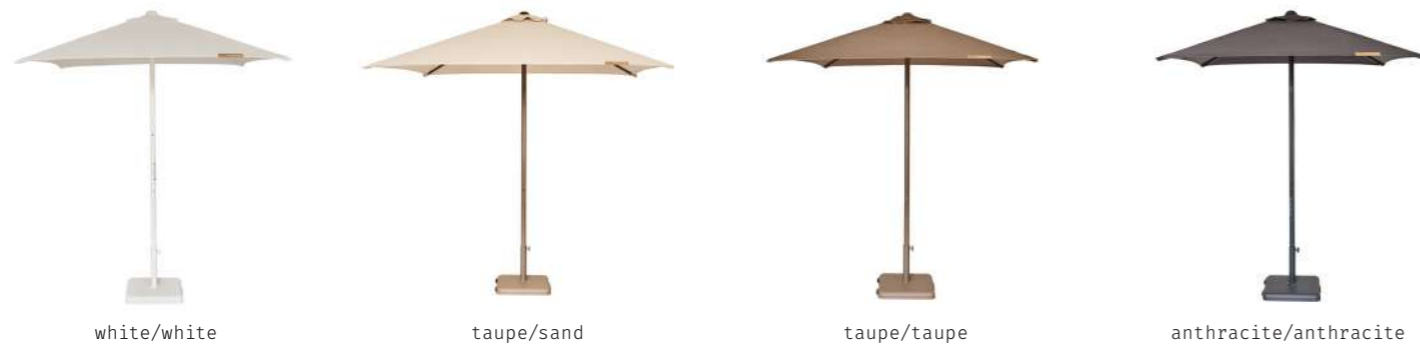

Tamaños / Tamanhos / Sizes / Tailles

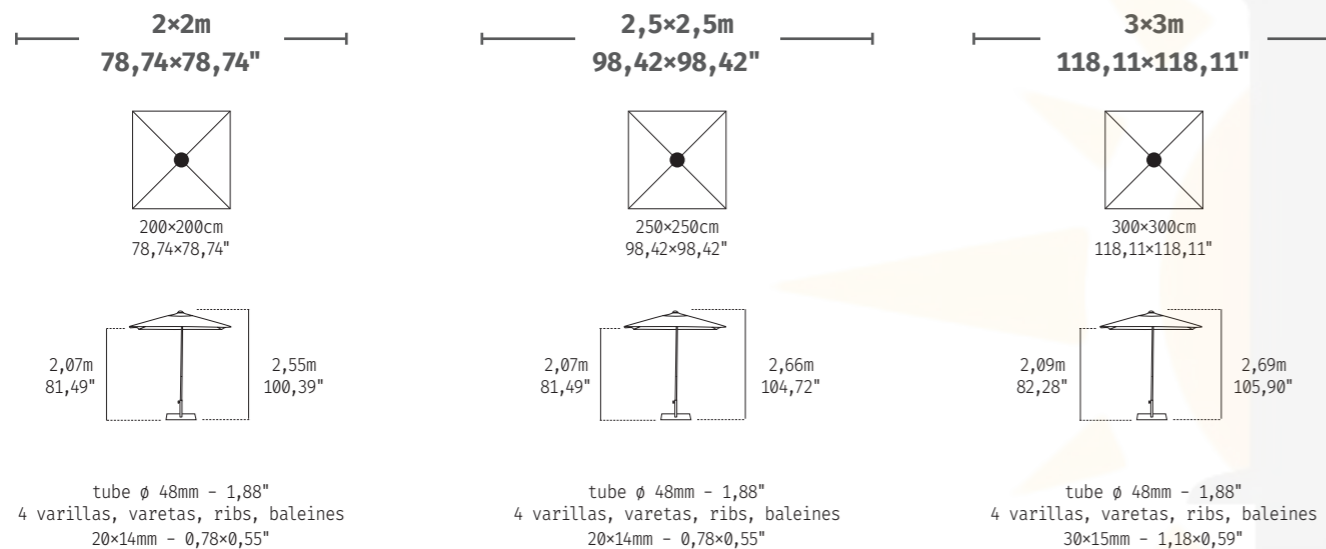

Tejidos / Tecidos / Fabrics / Tissus

Olefin

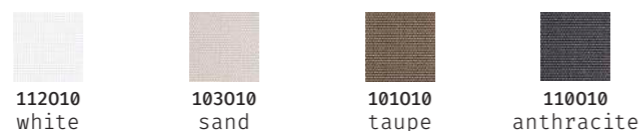

Bases / Pieds (Pag. 188-191)

•CUBE •FIX •FAST CLICK •BONDø60 •LOOP •CANTOø60

Referencias / Referências / References / Références

Color frame	2x2m - 78,74x78,74"	2,5x2,5m - 98,42x98,42"	3x3m - 118,11x118,11"
white	SPA010C2002721P	SIA010C2502720P	SGA010C3002720P
taupe	SPA010C2002821P	SIA010C2502820P	SGA010C3002820P
anthracite	SPA010C2002621P	SIA010C2502620P	SGA010C3002620P



Parasol de aluminio lacado con 4 varillas. Apertura tipo push-up con sistema abre/cierra y pulsador de bloqueo. Sin volante y con fugavientos.

Guarda-sol em alumínio lacado com 4 varetas. Abertura tipo push-up com sistema abre/fecha e botão de bloqueio. Sem babinela e com fugavientos.

Lacquered aluminum parasol with 4 ribs. Easy push-up open system with an open-lock handle. Without valance and with airvent.

Parasol aluminium laqué avec 4 baleines. Ouverture push-up avec système d'ouverture / fermeture et verrouillage. Sans volant et avec soufflet.

Registered design No. 007003710 - Utility model No. 201931894



EL PARASOL QUE PURIFICA EL AIRE - O GUARDA-SOL QUE PURIFICA O AR
THE PARASOL THAT PURIFIES THE AIR - LE PARASOL QUI PURIFIE L'AIR

pureti



Al igual que los árboles, el tejido de este parasol descontamina el aire de las ciudades, neutraliza los gases de los motores y otras sustancias nocivas. Incorpora una nanotecnología que, en contacto con la luz solar, convierte las sustancias contaminantes del aire en sales inertes.

Tal como as árvores, o tecido deste guarda-sol descontamina o ar das cidades, neutraliza os gases dos motores e outras substâncias nocivas. Tem incorporada uma nanotecnologia que, em contacto com a luz solar, converte as substâncias contaminantes do ar em sais inertes.

Much like trees, the fabric of this umbrella reduces city pollution, neutralizing engine gases and other harmful substances. Its nanotechnology, upon contact with sunlight, turns air pollutants into inert salts.

Tout comme les arbres, le tissu de ce parasol décontamine l'air des villes et neutralise les gaz d'échappement des moteurs et d'autres substances nocives. Il intègre une nanotechnologie qui, en contact avec la lumière du soleil, transforme les substances contaminantes de l'air en sels inertes.

EOLO



white

taupe

anthracite

Tamaños / Tamanhos / Sizes / Tailles

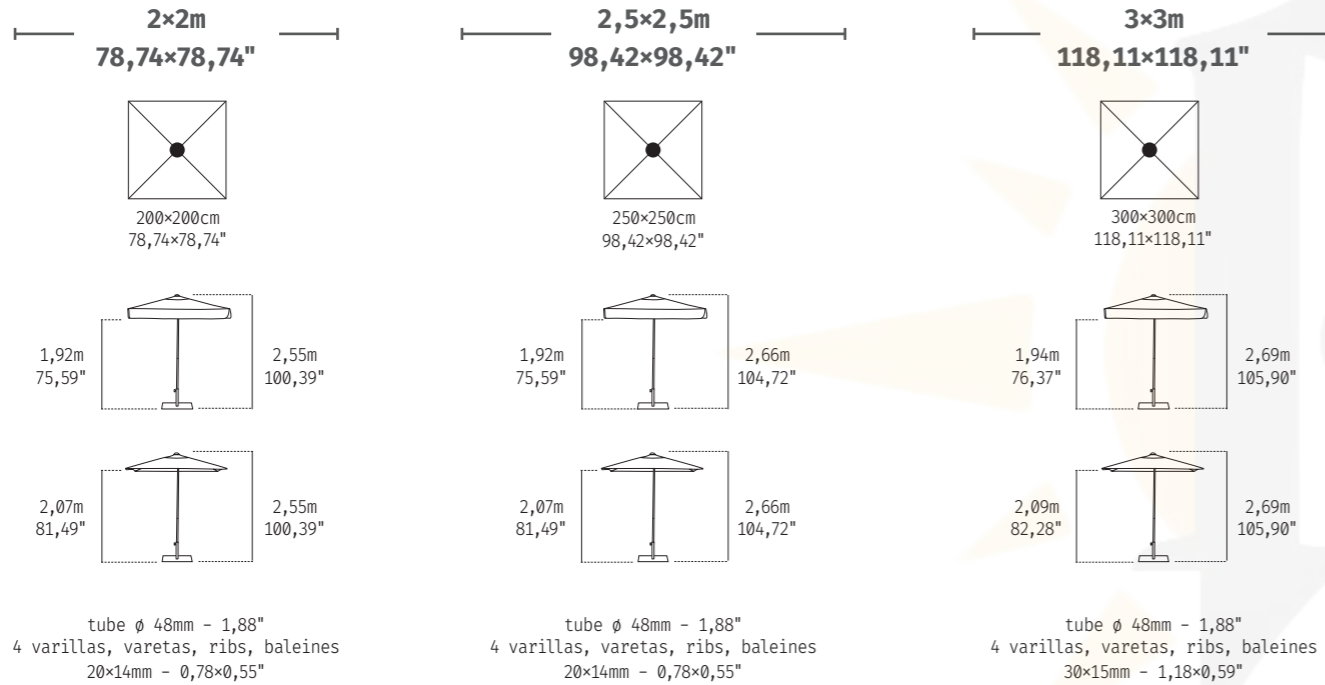

Tejidos / Tecidos / Fabrics / Tissus

Olefin



Sumbrella



NEW



Parasol de aluminio lacado con 4 varillas. Apertura tipo push-up con sistema abre/cierra y pulsador de bloqueo. Sin volante y con fugavientos.

Guarda-sol em alumínio lacado com 4 varetas. Abertura tipo push-up com sistema abre/fecha e botão de bloqueio. Sem babinela e com fugavientos.

Lacquered aluminum parasol with 4 ribs. Easy push-up open system with an open-lock handle. Without valance and with airvent.

Parasol aluminium laqué avec 4 baleines. Ouverture push-up avec système d'ouverture / fermeture et verrouillage. Sans volant et avec soufflet.

Registered design No. 007003710 - Utility model No. 201931894



+ INFO



Referencias / Referências / References / Références

Color frame	2x2m - 78,74x78,74"	2,5x2,5m - 98,42x98,42"	3x3m - 118,11x118,11"
olefin white	SPA010C2002740P	SIA010C2502740P	SGA010C3002740P
olefin taupe	SPA010C2002840P	SIA010C2502840P	SGA010C3002840P
olefin anthracite	SPA010C2002640P	SIA010C2502640P	SGA010C3002640P
olefin white	SPA010C2002720P	SIA010C2502721P	SGA010C3002721P
olefin taupe	SPA010C2002820P	SIA010C2502821P	SGA010C3002821P
olefin anthracite	SPA010C2002620P	SIA010C2502621P	SGA010C3002621P
sumbrella white	SPAD24C2002770P	SIAD24C2502771P	SGAD34C3002771P
sumbrella taupe	SPAD24C2002870P	SIAD24C2502871P	SGAD34C3002871P
sumbrella anthracite	SPAD24C2002670P	SIAD24C2502671P	SGAD34C3002671P

Bases / Pieds (Pag. 188-191)

•CUBE •FIX •FASTCLICK •BONDø60 •LOOP •CANTOø60

* Los parasoles white/white, taupe/taupe, taupe/sand y antracita/antracita son Pureti - Os guarda sois branco/branco, taupe/taupe, taupe/sande Antracita/Antracita são - Parasols white/white, taupe/taupe, taupe/sand and anthracite/anthracite are Pureti - Les parasols blanc/blanc, taupe/taupe, taupe/sand et antracite/antracite are Pureti - Les parasols blanc/blanc, taupe/taupe, taupe/sand et antracite/antracite are Pureti

FLEXO 3x3m - 118,11x118,11"



white

taupe

anthracite

Tamaños / Tamanhos / Sizes / Tailles

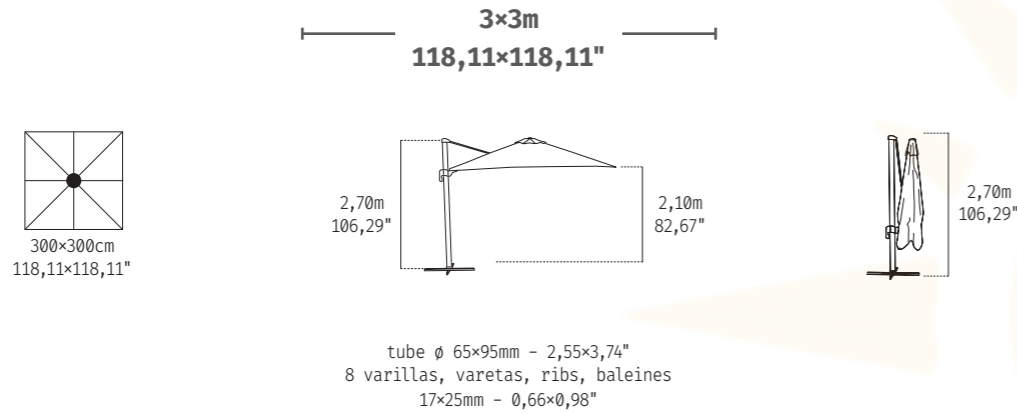

Tejidos / Tecidos / Fabrics / Tissus

Olefin



Bases / Pieds (Pag. 188-191)

•SLAB •KITFLEXO

Referencias / Referências / References / Références

Color frame	3x3m - 118,11x118,11"
white	SGA010C3005021P
taupe	SGA010C3005022P
anthracite	SGA010C3005020P



Sistema estabilizador. Stabilizer system. Système stabilisateur.

Parasol de aluminio de mastil lateral con inclinación. 8 varillas. Giratorio 360°. Sistema estabilizador. Sin volante y con fugavientos.
Guarda-sol em alumínio de haste lateral com inclinação. 8 varetas. Giratório 360°. Sistema estabilizador. Sem bambelina e com fugavientos.
Aluminium lateral pole parasol with tilt system. 8 ribs. 360° rotatory system. Stabilizer system. Without valance and with airvent.
Parasol mât latéral avec inclinaison. 8 baleines. Rotatif 360°. Système stabilisateur. Sans volant et avec soufflet.

(Cruceta incluida / cruzeta incluida / cross included / croix incluse)

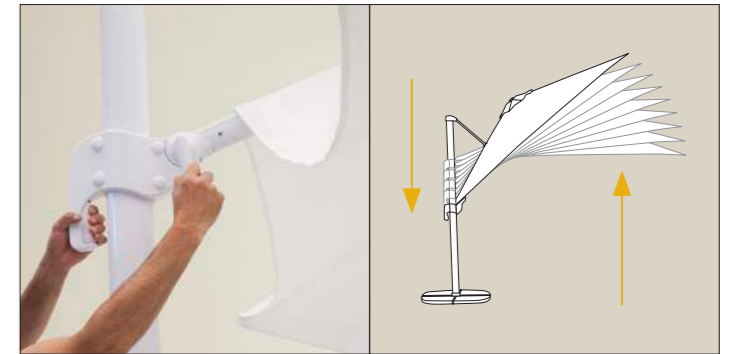

Tela multiposición. Tecido multiposições. Multi-position fabric. Tissu multipositions.

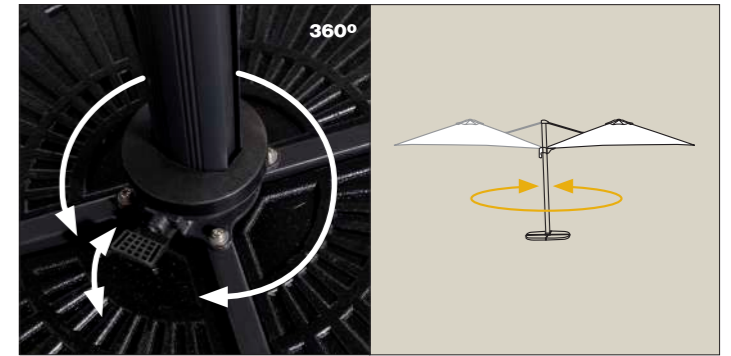

Sistema de rotación. Sistema de rotação. Rotation System. Système de rotation.



FLEXO PARASOL



FLEXO PARASOL
+
4 SLAB



FLEXO PARASOL
+
BASE FLEXO
+
6 SLAB }
KIT FLEXO

Usar con estas bases. Utilizar com estas bases. Use with these bases. A utiliser avec ces bases:

SLAB
o
KIT FLEXO

✓ Sistema de rotación. Sistema de rotação. Rotation System. Système de rotation.

✓ Más espacio debajo. Mais espaço em baixo. More space below. Plus d'espace ci-dessous.

✗ Ruedas. Rodas. Wheels. Roues.

✗ Sistema de rotación. Sistema de rotação. Rotation System. Système de rotation.

✓ Más espacio debajo. Mais espaço em baixo. More space below. Plus d'espace ci-dessous.

✓ Ruedas. Rodas. Wheels. Roues.

RIO 4x4m - 157,48x157,48"



white



anthracite

Tamaños / Tamanhos / Sizes / Tailles

4x4m
157,48x157,48"

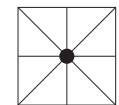

400x400cm
157,48x157,48"

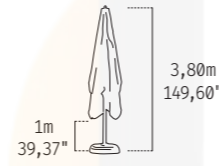
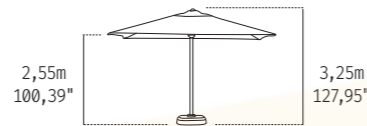
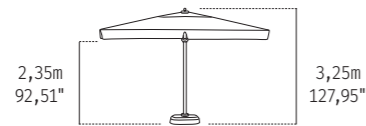

telescopic

tube ϕ 71x71mm - 2,79x2,79"
8 varillas, varetas, ribs, baleines
20x35x1,5mm - 0,78x1,37x0,05"

Tejidos / Tecidos / Fabrics / Tissus

Olefin 250g



212020
white



203020
sand



201020
taupe



210020
anthracite



202020
black

Bases / Pieds (Pag. 188-191)

•KIT CROSSRIO •FIXRIO •FAST CLICKRIO

Referencias / Referências / References / Références



olefin



olefin

Color frame	4x4m - 157,48x157,48"
white	SGA020C4000240P
anthracite	SGA020C4000440P
white	SGA020C4000220P
anthracite	SGA020C4000420P



Parasol de aluminio lacado para terrazas grandes. 8 varillas intercambiables. Apertura asistida manivela. Telescópico. Con o sin volante y con fugavientos.

Guarda-sol em alumínio lacado para esplanadas grandes. 8 varetas intercambiáveis. Abertura assistida manivela. Telescópico. Com ou sem babinela e com fugaventos.

Lacquered aluminium parasol for big terraces. 8 exchangeable ribs. Crank-assisted opening system. Telescopic. With or without valance and with airvent.

Parasol aluminium laqué pour grande terrasse. 8 baleines interchangeables. Ouverture assistée manivelle. Télescopique. Avec ou sans volant et avec soufflet.

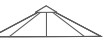

FORMENTERA



Tamaños / Tamanhos / Sizes / Tailles

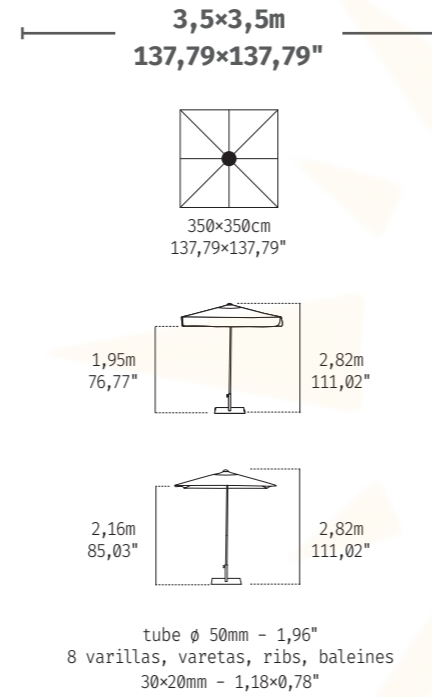
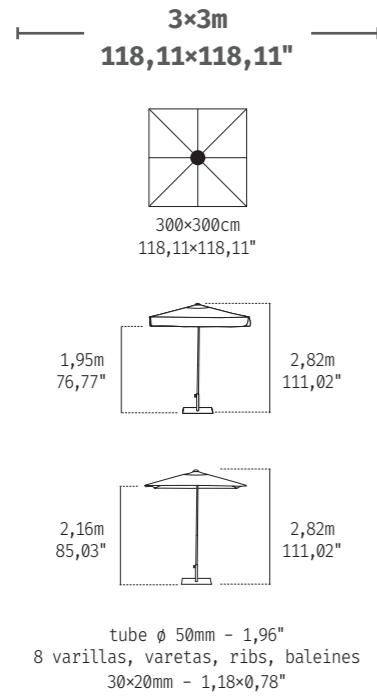

Tejidos / Tecidos / Fabrics / Tissus

Olefin



Bases / Pieds (Pag. 188-191)

•KIT CROSS(3,5x3,5) •CUBE •FIX •FAST CLICK •BOND ø60 (3x3) •LOOP •CANTO ø60



Parasol de aluminio lacado. 8 varillas. Apertura por poleas. Sin volante y con fugavientos.

Guarda-sol em alumínio lacado. 8 varetas. Abertura por roldanas. Sem bambinela e com fugaventos.

Lacquered aluminium parasol. 8 ribs. Pulley opening system. Without valance and with airvent.

Parasol aluminium laqué. 8 baleines. Ouverture par poulie. Sans volant et avec soufflet.

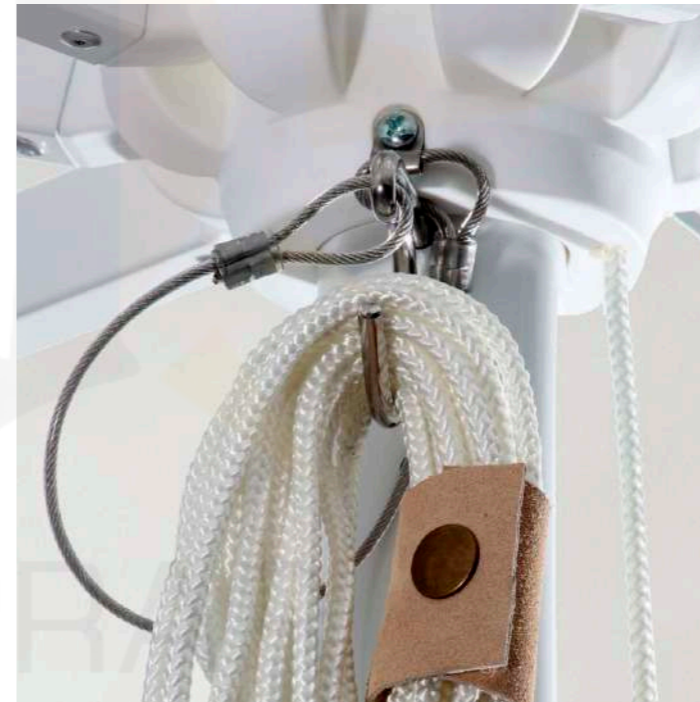

Referencias / Referências / References / Références

Color frame	3x3m - 118,11x118,11"	3,5x3,5m - 137,79x137,79"
white	SGA010C3000240P	SGA010C3500140P
anthracite	SGA010C3000540P	SGA010C3500340P
white	SGA010C3000220P	SGA010C3500120P
anthracite	SGA010C3000520P	SGA010C3500320P



FORMENTERA LATERAL

NEW



anthracite



Parasol de aluminio lacado de mástil lateral. 5 varillas. Apertura por poleas. Sin volante y con fugavientos.

Guarda-sol de mastro lateral em alumínio lacado. 5 varetas. Abertura por roldanas. Sem bambinela e com fugaventos.

Lacquered aluminum side mast parasol. 5 ribs. Pulley opening system. Without valance and with airvent.

Parasol lateral en aluminium laqué. 5 baleines. Ouverture par poulie. Sans volant et avec soufflet.

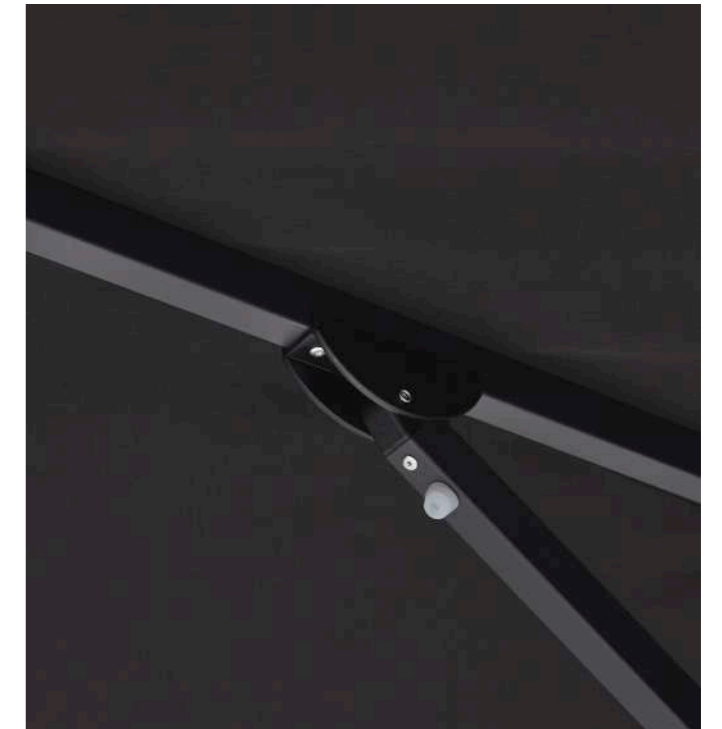

Tamaños / Tamanhos / Sizes / Tailles

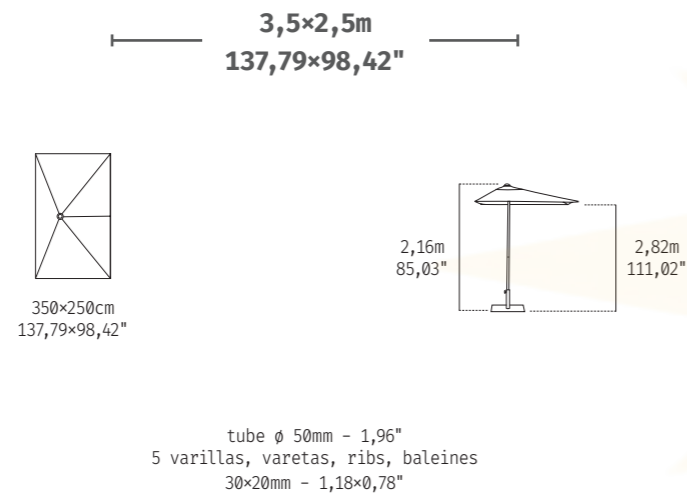

Tejidos / Tecidos / Fabrics / Tissus

Olefin



Bases / Pieds (Pag. 188-191)

•CANTO ϕ 60

Referencias / Referências / References / Références

	Color frame	3,5x2,5m - 137,79x98,42"
	anthracite	SGA010H3500020P



VIGO



grey

Tamaños / Tamanhos / Sizes / Tailles

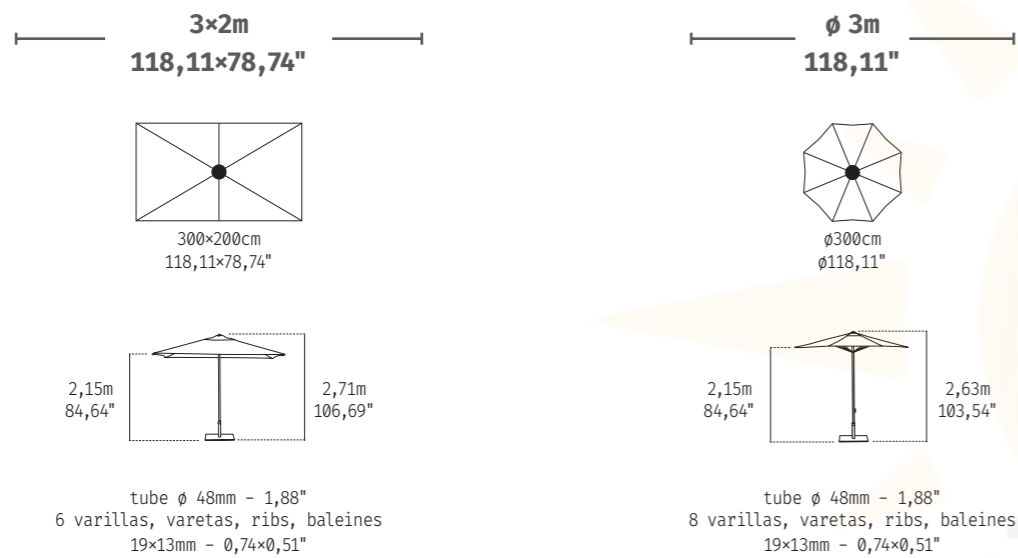

Tejidos / Tecidos / Fabrics / Tissus

Olefin



Bases / Pieds (Pag. 188-191)

•CUBE •FIX •FASTCLICK •BOND ϕ 60 •LOOP •CANTO ϕ 60

Referencias / Referências / References / Références

Color frame	3x2m - 118,11x78,74"	ϕ 3m - 118,11"
grey	SGA010H3000020P	SIA010030000820P



Parasol de aluminio lacado gris. 8 varillas. Apertura por poleas. Sin volante y con fugavientos.

Guarda-sol em alumínio lacado cinza. 8 varetas. Abertura por roldanas. Sem bambinela e com fugaventos.

Grey lacquered aluminium parasol. 8 ribs. Pulley opening system. Without valance and with airvent.

Parasol aluminium laqué gris. 8 baleines. Ouverture par poulie. Sans volant et avec soufflet.

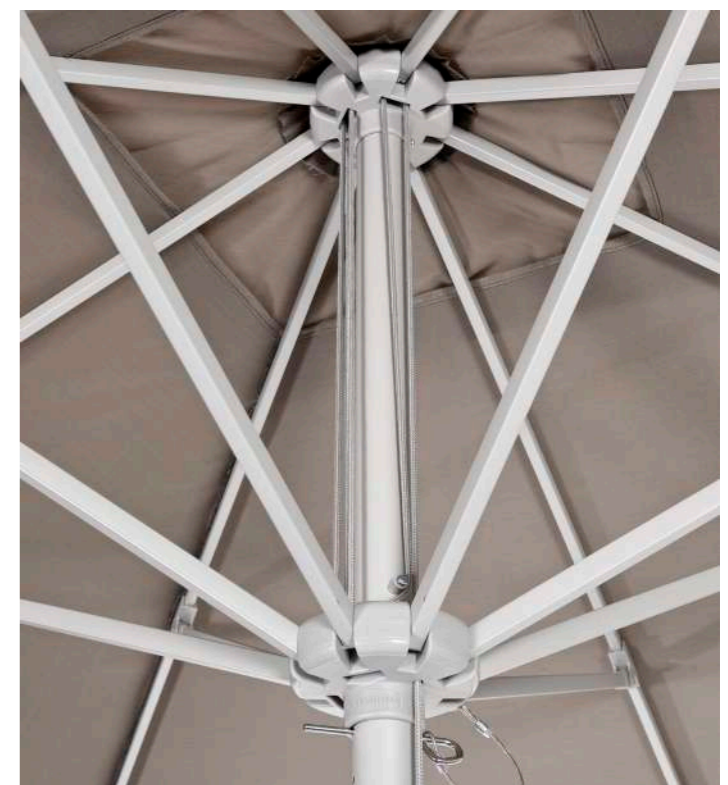

JAVA



Tamaños / Tamanhos / Sizes / Tailles

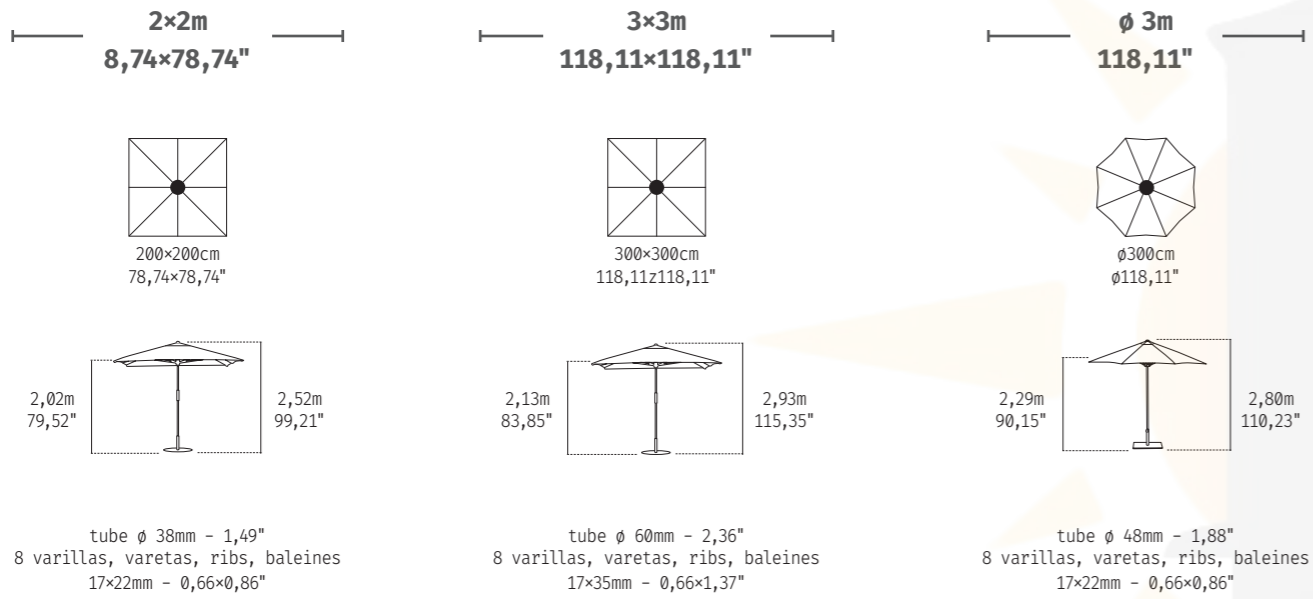

Tejidos / Tecidos / Fabrics / Tissus

Olefin



Bases / Pieds (Pag. 188-191)

• CUBE (2x2-Ø3) • FIX (Ø3) • FAST CLICK (Ø3) • BOND Ø60 (2x2-Ø3) • LOOP (2x2-Ø3) • CANTO Ø60 (2x2-Ø3) • CANTO Ø70 (3x3)

Referencias / Referências / References / Références

Color frame	2x2m - 78,74x78,74"	3x3m - 118,11x118,11"	Ø 3m - 118,11"
wood	SPM010C2000220P	SGM010C3000220P	SIM01003000720P



Parasol de madera de eucalipto barnizada. 8 varillas. Apertura por poleas. Sin volante y con fugavientos. Madera procedentes de fuentes sostenibles. Certificado FSC®.

Guarda-sol de madeira de eucalipto envernizada. 8 varetas. Abertura por roldanas. Sem bambinela e com fugavientos. Madeira proveniente de fontes reflorestadas. Certificado FSC®.

Varnished eucalyptus wood parasol. 8 ribs. Pulley opening system. Without valance and with airvent. Wood from reforested sources. FSC® certified.

Parasol bois d'eucalyptus verni. 8 baleines. Ouverture par poulie. Sans volant et avec soufflet. Bois provenant de sources reboisées. Certified FSC®.

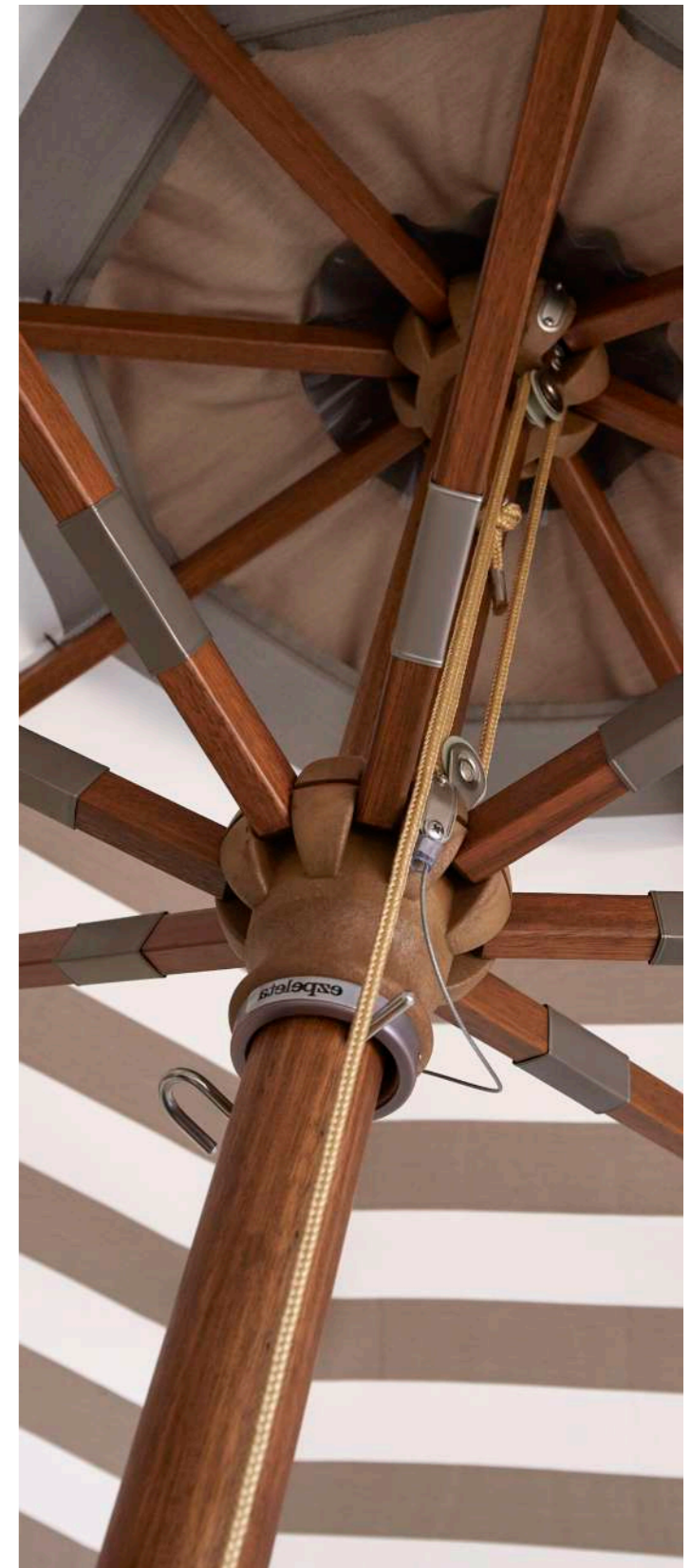

MADEIRA 3m - 118,11"

SIM01003000750P

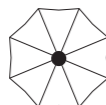

ø300cm
ø118,11"

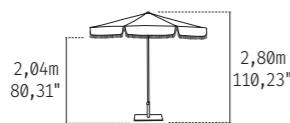

2,04m
80,31"

2,80m
110,23"

tube ø 48mm - 1,88"
8 varillas, varetas, ribs, baleines
17x22mm - 0,66x0,86"

Olefin



125010
blue
stripe



124010
green
stripe



Parasol de madera de eucalipto barnizada. 8 varillas.
Apertura por poleas. Con volante, fleco y fugavientos. Madera
procedente de fuentes sostenibles. *Certificado FSC®.*
Guarda-sol de madeira de eucalipto envernizada. 8 varetas.
Abertura por roldanas. Com bambinela, franjas e fugaventos.
Madeira proveniente de fontes reflorestadas. Certificado FSC®.
Varnished eucalyptus wood parasol. 8 ribs. Pulley opening
system. With valance, fringes and airvent. Wood from reforested
sources. FSC® certified.

Parasol bois d'eucalyptus verni. 8 baleines. Ouverture par poulie.
Avec volants, franges et soufflet. Bois provenant de sources
robisées. Certified FSC®.



Bases / Pieds (Pag. 188-191)

- CUBE
- FIX
- FAST CLICK
- BOND ø60
- LOOP
- CANTO ø60

PALMA GREY 2,5m - 98,42"

SIA01002500000P

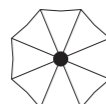

ø250cm
ø98,42"

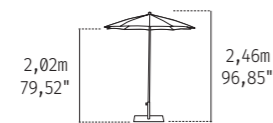

2,02m
79,52"

2,46m
96,85"

tube ø 40-45mm - 1,57-1,77"
8 varillas, varetas, ribs, baleines
8mm - 0,31"

Olefin



112010
white



103010
sand



101010
taupe



110010
anthracite

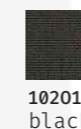

102010
black



109010
moka



121010
olivo

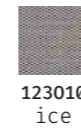

123010
ice



122010
sky blue

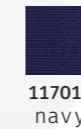

117010
navy

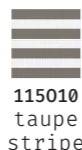

115010
taupe
stripe



116010
anthracite
stripe



125010
blue
stripe

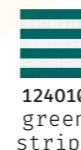

124010
green
stripe



Parasol de aluminio. 8 varillas de fibra de vidrio. Regulable en
altura. Sin volante y sin fugavientos. Capito T extrarresistente.
Guarda-sol em aluminio. 8 varetas de fibra de vidro. Regulável em
altura. Sem bambinela e sem fugaventos. Tip T extraforte.
Aluminium parasol. 8 fiberglass ribs. Adjustable height. Without
valance and without airvent. Extrarresistant T tip.
Parasol aluminium. 8 baleines en fibre de verre. Ajustable en
hauteur. Sans volant et sans soufflet. Tip T extra forte.



Bases / Pieds (Pag. 188-191)

- BOND ø60
- LOOP

MENORCA 2,5m - 98,42"

SIA01002500006P

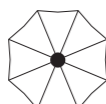

ø250cm
ø98,42"

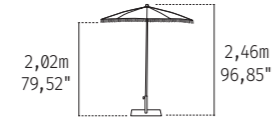

2,02m
79,52"

2,46m
96,85"

tube ø 40-45mm - 1,57-1,77"
8 varillas, varetas, ribs, baleines
8mm - 0,31"

Olefin



121010
olivo



123010
ice



122010
sky blue



Parasol de aluminio. 8 varillas de fibra de vidrio. Regulable
en altura. Sin volante y sin fugavientos. Con flecos. Capito T
extrarresistente.
Guarda-sol em aluminio. 8 varetas de fibra de vidro. Regulável
em altura. Sem bambinela e sem fugaventos. Com franjas. Tip T
extraforte.
Aluminium parasol. 8 fiberglass ribs. Adjustable height. Without
valance and without airvent. Whit fringes. Extrarresistant T tip.
Parasol aluminium. 8 baleines en fibre de verre. Ajustable en
hauteur. Sans volant et sans soufflet. Avec franges. Tip T extra
forte.



Bases / Pieds (Pag. 188-191)

- BOND ø60
- LOOP

TENERIFE INOX 2m - 78,74"

SPI010D2005310P

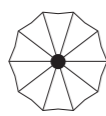

Ø200cm
Ø78,74"

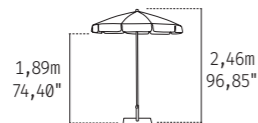

1,89m
74,40" 2,46m
96,85"

tube Ø 28-35mm - 1,10-1,37"
10 varillas, varetas, ribs, baleines
6mm - 0,23"



112010
white



103010
sand



101010
taupe



110010
anthracite



102010
black



109010
moka



121010
olivo



123010
ice



122010
sky blue



117010
navy



115010
taupe
stripe



116010
anthracite
stripe



125010
blue
stripe



124010
green
stripe

Olefin



Parasol de INOX con inclinación. 10 varillas de fibra de vidrio. Regulable en altura. Con volante y sin fugavientos. Capito T extrarresistente.

Guarda-sol em INOX com inclinação. 10 varetas de fibra de vidro. Regulável em altura. Com bambelina e sem fugavientos. Tip T extraforte.

INOX parasol with tilt system. 10 fiberglass ribs. Adjustable height. With valance and without airvent. Extrarresistant T tip.

Parasol INOX avec inclinaison. 10 baleines en fibre de verre. Ajustable en hauteur. Avec volants et sans soufflet. Tip T extra forte.



Bases / Pieds (Pag. 188-191)

- BOND Ø45
- FIT Ø45

ONS SAND 2m - 78,74"

SPA010D2000110T

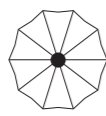

Ø200cm
Ø78,74"

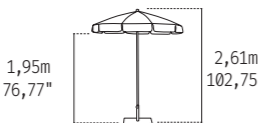

1,95m
76,77" 2,61m
102,75"

tube Ø 29-32mm - 1,14-1,25"
10 varillas, varetas, ribs, baleines
6mm - 0,23"



112010
white



103010
sand



101010
taupe



110010
anthracite

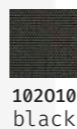

102010
black



109010
moka



121010
olivo



123010
ice

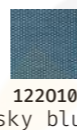

122010
sky blue



117010
navy

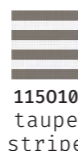

115010
taupe
stripe



116010
anthracite
stripe



125010
blue
stripe



124010
green
stripe

Olefin



Parasol de aluminio lacado sand. 10 varillas de fibra de vidrio. Regulable en altura. Con volante y sin fugavientos. Capito T extrarresistente.

Guarda-sol em alumínio lacado sand. 10 varetas de fibra de vidro. Regulável em altura. Com bambelina e sem fugavientos. Tip T extraforte.

Sand lacquered aluminium parasol. 10 fiberglass ribs. Adjustable height. With valance and without airvent. Extrarresistant T tip.

Parasol aluminium laqué sand. 10 baleines en fibre de verre. Ajustable en hauteur. Avec volants et sans soufflet. Tip T extra forte.



Bases / Pieds (Pag. 188-191)

- BOND Ø45
- FIT Ø40

NEW TOSCANA

SPA010D2000150T

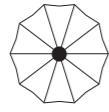

∅200cm
∅78,74"



1,89m
74,40" 2,61m
102,75"

tube ∅ 29-32mm - 1,14-1,25"
10 varillas, varetas, ribs, baleines
6mm - 0,23"

Olefin



0011010
olivo/sand



0012010
sky blue/sand



103010
sand/sand



Parasol de aluminio lacado sand. 10 varillas de fibra de vidrio. Regulable en altura. Con flecos. Con volante y sin fugavientos. Capito T extrarresistente.

Guarda-sol em alumínio lacado sand. 10 varetas de fibra de vidro. Regulável em altura. Com franjas. Com bambelina e sem fugavientos. Tip T extraforte.

Sand lacquered aluminium parasol. 10 fiberglass ribs. Adjustable height. With fringes. With valance and without airvent. Extrarresistant T tip.

Parasol aluminium laqué sand. 10 baleines en fibre de verre. Ajustable en hauteur. Avec franges et volants et sans soufflet. Tip T extra forte.



OLEFIN
FIBER
190g

Bases / Pieds (Pag. 188-191)

- BOND∅45
- FIT∅40

MANILA NATURAL 2m - 78,74"

SPSZ02D2000001T

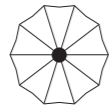

∅200cm
∅78,74"



1,89m
74,40" 2,61m
102,75"

tube ∅ 29-32mm - 1,14-1,25"
10 varillas, varetas, ribs, baleines
6mm - 0,23"



Parasol de acero imitación madera natural. 10 varillas de fibra de vidrio. Regulable en altura. Con volante y sin fugavientos.

Guarda-sol em aço imitação madeira natural. 10 varetas de fibra de vidro. Regulável em altura. Com bambelina e sem fugavientos.

Natural wood finishing steel parasol. 10 fiberglass ribs. Adjustable height. With valance and without airvent.

Parasol acier finition bois naturel. 10 baleines en fibre de verre. Ajustable en hauteur. Avec volants et sans soufflet.



UPF50+

Bases / Pieds (Pag. 188-191)

- BOND∅45
- FIT∅40

FUNDA PARASOL - CAPA GUARDA-SOL - PARASOL COVER - COUVERTURE PARASOL



REF. 31P18C40000

RIO 400X4000

REF. 31P18C30000

FORMENTERA 300X300
VIGO 300X300 - JAVA 300X300

REF. 31P18C35000

FORMENTERA 350X350
FLEXO 300X300

REF. 31P18C25000

EOLO - VIGO - JAVA

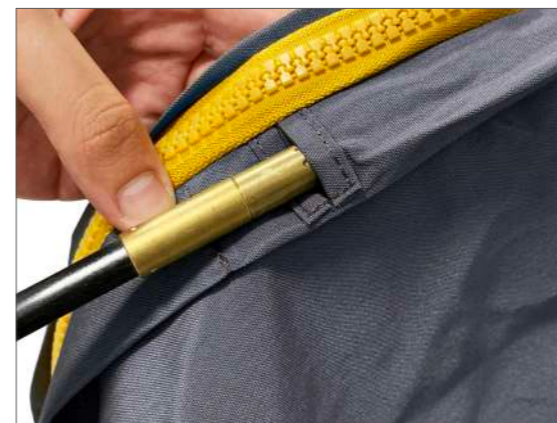

POLYESTER
210g

WATER PROOF

+ INFO



SUNBRELLA

Tejido exclusivamente con fibras acrílicas teñidas en masa desde el núcleo del mismo hilo para garantizar su resistencia a la decoloración frente a los rayos UV. Acabado repelente al agua, resistente al moho y antimanchas que protege el tejido y hace que su mantenimiento sea muy sencillo.

Garantía de 5 años frente a la abrasión, la aparición de bolitas, la decoloración y la pérdida de tensión.

Cuenta con el Sello de Recomendación de la Skin Cancer Foundation (Fundación contra el Cáncer de la Piel) que garantiza la protección de la piel de los efectos nocivos de los rayos UV.

Tecido exclusivamente com fibras acrílicas tingidas em massa a partir do núcleo do próprio fio para garantir a sua resistência à descoloração contra os raios UV. O acabamento repelente à água, ao mofo e às manchas protege o tecido e facilita a sua manutenção.

5 anos de garantia contra abrasão, borboto, descoloração e perda de tensão.

Com o Selo de Recomendação da "Skin Cancer Foundation" que garante a proteção da pele contra os efeitos nocivos dos raios UV.

The fabric is exclusively crafted from acrylic fibers, dyed thoroughly within the core of the yarn to ensure resistance against UV-induced fading. It is water-repellent, mold-resistant, and stain-repellent finish safeguards the fabric, simplifying maintenance.

It is backed by a 5-year warranty against abrasion, pilling, fading, and tension loss.

Endorsed by the Skin Cancer Foundation Seal, guaranteeing protection against the harmful effects of UV rays on the skin.

Tissu exclusivement en fibres acryliques teinté à la masse depuis son processus initial, afin de garantir une haute résistance à la décoloration due aux rayons UV. Toile déperlante, résistante aux moisissures, anti-tâches qui facilite ainsi son entretien.

Toile garantie 5 ans, contre l'abrasion, les bouloches, decoloration et pertes de tension.

Certifiée est recommandée par la "SKIN CANCER FONDATION" qui garantit la protection de la peau aux effets nocifs des rayons UV.

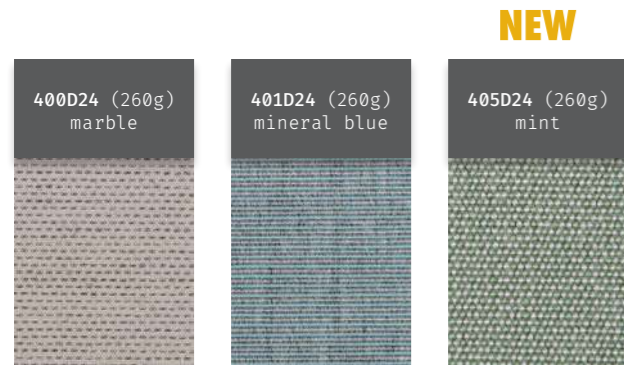

NEW NAUTIC (Ibiza & Nana colchón/colchão/mattress/matelas)

Tejido repelente al agua, confeccionado en PCV y polyester. Gran resistencia a los rayos UV (Solidez a la luz >7). Antibacteriano y antimoho. Certificado BLUEWORLD.

Tecido repelente à água, fabricado em PCV e poliéster. Elevada resistência aos raios UV (solidez à luz >7). Anti-bacteriano e anti-bolor. Certificado BLUEWORLD.

Water repellent fabric, made of PCV and polyester. High UV resistance (Light fastness >7). Antibacterial and anti-mould. BLUEWORLD certified.

Tissu hydrofugé, composé de PCV et de polyester. Grande résistance aux rayons UV (solidité à la lumière >7). Anti-bactérien et anti-moisissure. Certifié BLUEWORLD.



OLEFIN

Alta solidez de los colores a la radiación UV (7/8). Se trata de un tejido fabricado con hilo de polipropileno que ha sido tintado en masa, en su proceso inicial. Esto le otorga una gran resistencia a la luz solar ya que el color queda fijado en el hilo del tejido con mayor intensidad que en otros procesos. Dependiendo del color varía la durabilidad de la intensidad de los colores a la exposición solar.

Certificación UV standard 801 con la puntuación UPF 80, que garantiza la protección de la piel de los efectos nocivos de los rayos UV.

Resistente a las manchas - 100% reciclable.

Alta resistência das cores face à radiação UV. Ao ser um tecido fabricado com fio de polipropileno tingido em massa no seu processo inicial, esta característica confere-lhe uma maior resistência à luz solar o que se deve essencialmente ao facto de a cor permanecer fixa ao fio com maior intensidade do que em outros processos de pigmentação. A durabilidade da intensidade das cores, varia dependendo da cor e da exposição solar.

Certificação UV standard 801 com factor de proteção UPF 80, que garante a proteção da pele dos efeitos nocivos dos raios UV.

Anti-manchas - 100% reciclável.

High resistance of colours to UV radiation (7/8). The fabric is made from polypropylene fabric mass-dyed during the initial process. This provides high resistance to sunlight because the colour is set in the thread of the fabric more intensely than in other processes. Depending on the color, the durability of color intensity varies when exposed to sunlight.

UV standard 801 certification rating UPF 80, that guarantees skin protection against nocive effects of UV rays on the skin.

Stain resistance - 100% recyclable.

Haute résistance des couleurs face à la radiation solaire. Il s'agit ici d'une toile fabriquée à partir d'un fil en polypropylène qui a été teinté en masse, depuis son processus initial. Ceci lui confère une haute résistance à la lumière solaire, étant donné que la teinte reste fixée sur le fil avec une plus grande intensité en comparaison avec d'autres processus de pigmentation. Selon la couleur choisie, la durabilité de l'intensité de celle-ci varie en fonction de l'exposition au soleil.

Certification UV standard 801 avec un facteur de protection UPF 80, qui garantie une protection de la peau face aux effets nocifs des rayons UV.

Résistante toile aux tâches - 100% recyclable.

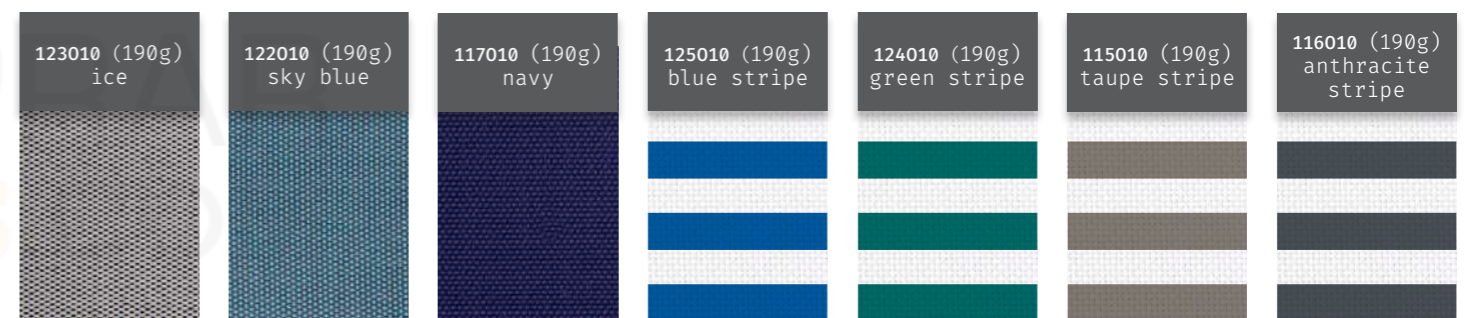

SOLUTION DYED - COLOUR FASTNESS: 7-8/8 - 100% RECYCLABLE

Disponemos de un tejido de poliéster 100% tintado en masa para pedidos con logotipo.
 Temos um tecido 100% poliéster tingido em massa para pedidos com logotipo.
 We have a 100% mass-dyed polyester fabric for orders with a logo.
 Nous avons un tissu 100% polyester teint dans la masse pour les commandes avec logo.

* Solidez 7-no recomendado para zonas de alta radiación solar. Solidez 7-Não recomendado para áreas de alta exposição solar. Color fastness rating 7-not recommended for areas of high solar radiation. Sa solidité est de 7-Déconseillé pour des zones à fort rayonnement solaire.

SLAB (hormigón/polipropileno - betão/polipropileno - concrete/polypropylene - béton/polypropylène)

Flexo
Kit flexo
Kit Cross
Kit Cross Rio

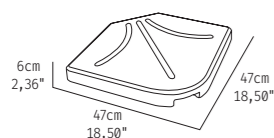

BEC047BC03
white



BEC047TP00
taupe



BEC047NG02
anthracite

25kg-55,11lb
100kg-220,46lb (4 U/)

- Peso de hormigón/polipropileno.
- *Peso em betão/polipropileno.*
- Concrete/polypropylene weight.
- *Poids en béton/polypropylène*

KIT FLEJO (hierro/hormigón/polipropileno - ferro/betão/polipropileno - iron/concrete/ polypropylene - fer/béton/polypropylène)

Flexo

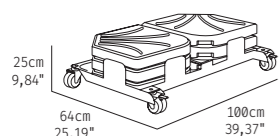

150kg-330,69lb + 15kg-33,06lb (base)



BSH990BCK
white



BSH990TPK
taupe



BSH990ANK
black

- Base lateral de hierro cincado con ruedas y pesos de hormigón/polipropileno. *El sistema de rotación del parasol Flexo no vale para esta base.
- *Base lateral em ferro zincado com rodas e pesos em betão/polipropileno. *O sistema de rotação do guarda-sol Flexo não pode ser utilizado para esta base.*
- Zinc-plated iron side base with castors and concrete/polypropylene weights. *The rotation system of the Flexo parasol is not suitable for this base.
- *Base latérale en fer zingué avec roulettes et poids en béton/polypropylène. *Le système de rotation du parasol Flexo n'est pas adapté à cette base.*

KIT CROSS RIO (hierro/hormigón - ferro/betão - iron/concrete - fer/béton)

Rio

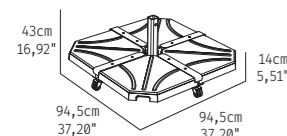

100kg-220,46lb + 10kg-22,04lb (base)
tube ø57mm-2,24"

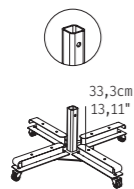

BSRDBC6010K
CROSS RIO - white



BSRDAN6010K
CROSS RIO - anthracite

- Base de hierro cincado con ruedas y pesos de hormigón/polipropileno.
- *Base em ferro zincado com rodas e pesos em betão/polipropileno.*
- Zinc-plated iron base with castors and concrete/polypropylene weights.
- *Base en fer zingué avec roulettes et poids en béton/polypropylène.*

KIT CROSS (hierro/hormigón - ferro/betão - iron/concrete - fer/béton)

Formentera
Eolo 3x3

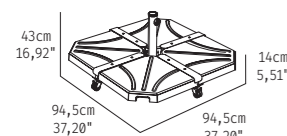

100kg-220,46lb + 10kg-22,04lb (base)
tube ø57mm-2,24"

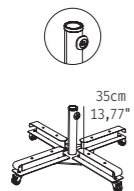

BSRDBC6001K
CROSS - white



BSRDAN6001K
CROSS - anthracite



BSRDTP6001K
CROSS - taupe

- Base de hierro cincado con ruedas y pesos de hormigón/polipropileno.
- *Base em ferro zincado com rodas e pesos em betão/polipropileno.*
- Zinc-plated iron base with castors and concrete/polypropylene weights.
- *Base en fer zingué avec roulettes et poids en béton/polypropylène.*

CUBE (hormigón - betão - concrete - béton)

Eolo
Formentera
Vigo
Java 3
Madeira

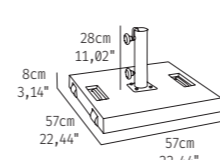

50kg-110,23lb
tube ø57mm-2,24"



BEC570BC00
white



BEC570GR00
grey



52CUBEK
KIT 2 ASAS/PEGAS/HANDLES/POIGNÉES + INOX TUBE

- Base de hormigón con ruedas. Tubo y asas de acero galvanizado.
- *Base em betão com rodas. Tubo e pegas em aço galvanizado.*
- Concrete base with wheels. Galvanised steel tube and handles.
- *Base en béton avec roues. Tube et poignées en acier galvanisé.*

FIX RIO (hierro - ferro - iron - fer)

Rio

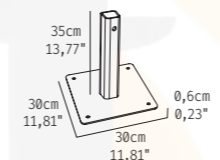

10kg-22,04lb
tube ø60mm-2,36"



BSC310BC63501
FIX RIO
white



BSC310AN63500
FIX RIO
anthracite

- Base de hierro con cataforesis para atornillar a suelo.
- *Base em ferro com cataforese para aparafusar ao chão.*
- Cataphoresis iron base for bolting to the floor.
- *Base en fer cataphorisée à fixer au sol.*

FIX (hierro - ferro - iron - fer)

Eolo
Formentera
Vigo
Java 3
Madeira

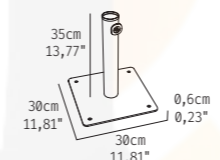

10kg-22,04lb
tube ø60mm-2,36"



BSC310GR6000
FIX
grey



BSC310BC6000
FIX
white



BSC310TP6000
FIX
taupe



BSC310AN6000
FIX
anthracite

- Base de hierro con cataforesis para atornillar a suelo.
- *Base de ferro com cataforese para aparafusar ao chão.*
- Cataphoresis iron base for bolting to the floor.
- *Base en fer cataphorisée à fixer au sol.*



FAST CLICK RIO (inox)

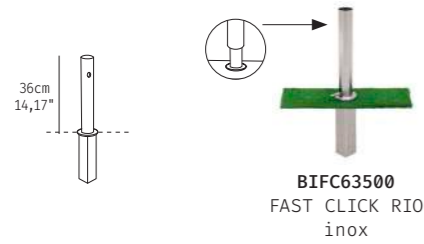

BIFC63500
FAST CLICK RIO
inox

- Base de acero inoxidable para incrustar en el suelo.
- Base em aço inox para embutir no pavimento.
- Stainless steel base for embedding in the floor.
- Base en acier inoxydable pour scellage au sol.

Rio



FAST CLICK (inox)



BIFC6000 - $\phi 60$
FAST CLICK
inox

BIFC5500 - $\phi 55$
FAST CLICK
inox

- Base de acero inoxidable para incrustar en el suelo.
- Base em aço inox para embutir no pavimento.
- Stainless steel base for embedding in the floor.
- Base en acier inoxydable pour scellage au sol.

Tubo $\phi 55$:
Eolo
Vigo
Java 3
Madeira

Tubo $\phi 60$:
Formentera



BOND 35 (hormigón/polipropileno - betão/polipropileno - concrete/polypropylene - béton/polypropylène)

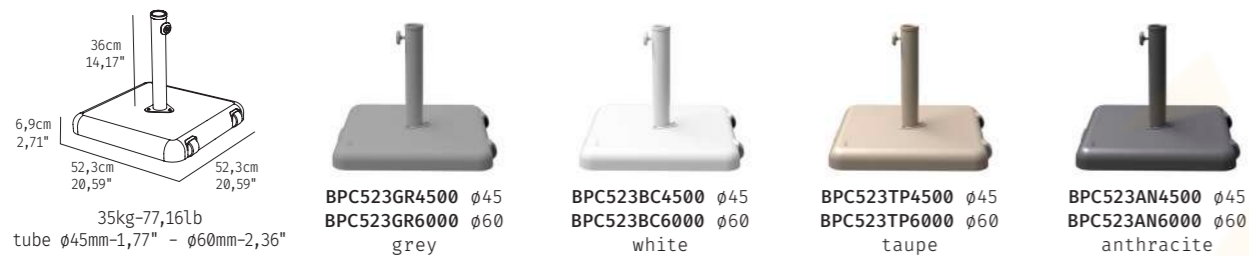

BPC523GR4500 $\phi 45$
BPC523GR6000 $\phi 60$
grey

BPC523BC4500 $\phi 45$
BPC523BC6000 $\phi 60$
white

BPC523TP4500 $\phi 45$
BPC523TP6000 $\phi 60$
taupe

BPC523AN4500 $\phi 45$
BPC523AN6000 $\phi 60$
anthracite

- Base de hormigón con carcasa de polipropileno, tubo de acero lacado con tratamiento antióxido (cataforesis), tornillería de acero inoxidable y ruedas.
- Base de betão com revestimento em polipropileno, tubo em aço lacado com tratamento anti-ferrugem (cataforese), parafusos em aço inoxidável e com rodas.
- Concrete base with polypropylene casing, anti-rust treated (cataphoresis) coated steel tubing, castors and stainless steel screws.
- Base en béton revêtit de polypropylène, tube en acier laqué avec traitement anti-rouille (cataphorèse), vis et roues en acier inoxydable.

Tubo $\phi 45$:
Tenerife
Ons
Toscana
Manila

Tubo $\phi 60$:
Eolo
Formentera
Vigo
Java 2x2
Java 3
Madeira
Palma
Menorca



BOND 50 (hormigón/polipropileno - betão/polipropileno - concrete/polypropylene - béton/polypropylène)



BPC590GR6000
grey

BPC590BC6000
white

BPC590TP6000
taupe

BPC590AN6000
anthracite

- Base de hormigón con carcasa de polipropileno, tubo de acero lacado con tratamiento antióxido (cataforesis), tornillería de acero inoxidable y ruedas.
- Base de betão com revestimento em polipropileno, tubo em aço lacado com tratamento anti-ferrugem (cataforese), parafusos em aço inoxidável e com rodas.
- Concrete base with polypropylene casing, anti-rust treated (cataphoresis) coated steel tubing, castors and stainless steel screws.
- Base en béton revêtit de polypropylène, tube en acier laqué avec traitement anti-rouille (cataphorèse), vis et roues en acier inoxydable.

Eolo
Formentera
Vigo
Java 2x2
Java 3
Madeira
Palma
Menorca

NEW



LOOP (hierro - ferro - iron - fer)

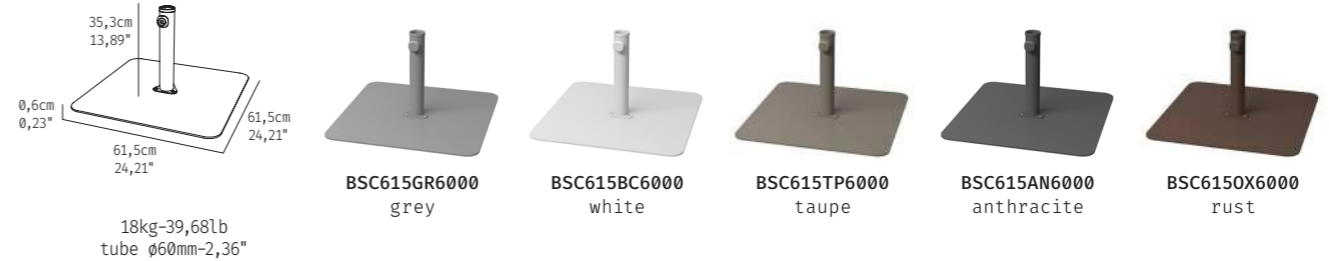

BSC615GR6000
grey

BSC615BC6000
white

BSC615TP6000
taupe

BSC615AN6000
anthracite

BSC615OX6000
rust

18kg-39,68lb
tube $\phi 60$ mm-2,36"

- Base de hierro con tratamiento antióxido (cataforesis). Tornillería en acero inoxidable.
- Base de ferro con tratamento anti-ferrugem (cataforese). Parafusos em aço inoxidável.
- Iron base with anti-rust treatment (cataphoresis). Stainless steel screws.
- Base en fer avec traitement anti-rouille (cataphorèse). Vis en acier inoxydable.

Eolo
Formentera
Vigo
Java 2x2
Java 3
Madeira
Palma
Menorca

NEW

CANTO (hierro - ferro - iron - fer)



BSC625GR6010 $\phi 60$
grey

BSC625BC6010 $\phi 60$
white

BSC625TP6010 $\phi 60$
taupe

BSC625AN6010 $\phi 60$
anthracite

BSC625OX6010 $\phi 60$
BSC625OX7010 $\phi 70$
rust

35kg-77,16lb
tube $\phi 60$ mm-2,36" - $\phi 70$ mm-2,75"

- Base de doble chapa de hierro. Cantoneras de acero inoxidable para separar la chapa del suelo. Ruedas con freno. Accesorio: Ruedas con freno.
- Base da placa dupla em ferro. Cantos em aço inoxidável para separar a placa do chão. Acessório: Rodas com freio.
- Double iron plate base. Stainless steel corners to separate the plate from the floor. Accessory: Wheels with brake.
- Double base en fer. Coins en acier inoxydable pour séparer la plaque du sol. Accessoire: Roues avec frein.

Tubo $\phi 60$:
Eolo
Formentera
Formentera Lateral
Vigo

Java 2x2
Java 3
Madeira
Palma
Menorca

Tubo $\phi 70$:
Java 3x3



MO-SIE41K (kit 4 U)
Rueda con freno - roda com travão - wheels with brake - roue avec frein.

FIT (hierro - ferro - iron - fer)



BS0500GR4003 $\phi 40$
BS0500GR4503 $\phi 45$
grey

BS0500BC4002 $\phi 40$
white

BS0500OX4000 $\phi 40$
rust

12kg-26,45lb
tube $\phi 40$ mm-1,57" - $\phi 45$ mm-1,77"

- Base octogonal de hierro.
- Base de ferro octogonal.
- Octagonal iron base.
- Base octogonale en fer.

Tubo $\phi 40$:
Ons
New
Toscana
Manila

Tubo $\phi 45$:
Tenerife